

M'ALPINE

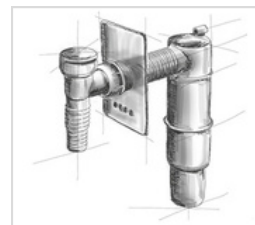

FLEXCONN-4032-WH REDUKCJA KANALIZACYJNA BIAŁA

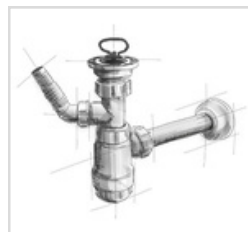
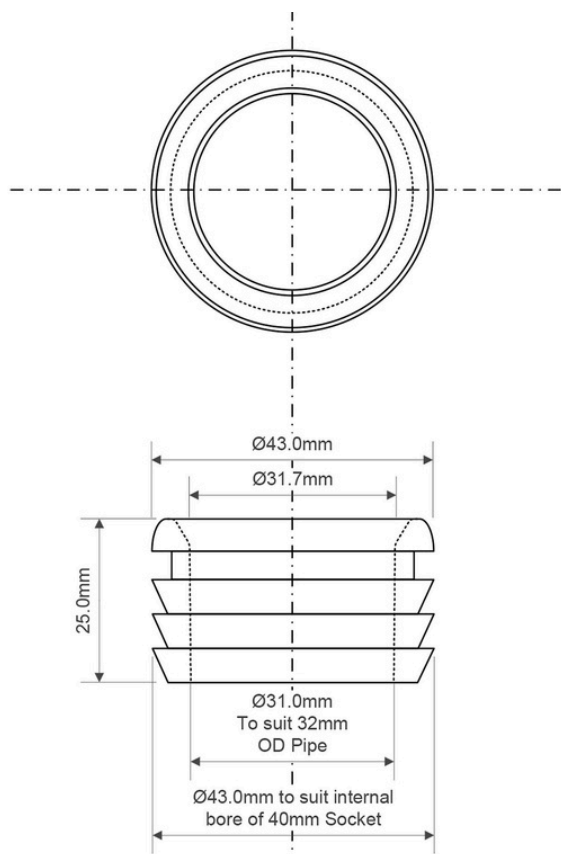

SPECYFIKACJA:

Redukcja kanalizacyjna 40x32mm, biała

Materiał: elastomer termoplastyczny (tzw. TPE)

Kolor: biały

Waga produktu: 0,08 kg

Norma: PN-EN 681-2:202

PAKOWANIE:



50 szt.



290x260x150 mm



0,8 kg

Kod EAN: 5036484069498